

Erica EUX 611 78 Specifications

- 1 x 45mm Waste with overflow
- Symmetrical design
- Fits into 500mm base unit
- Adequate size for small linear runs

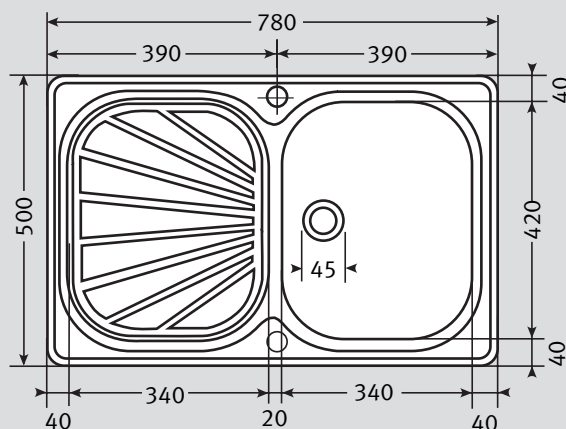

Material:	Stainless Steel
Application:	Inset or undermounted
Bowl Size:	340 x 420 x 175 (Welded to frame)
Drainer Format:	Reversible
Cut-out Size:	764 x 484 (cr=20)
Colour:	Silk Stainless Steel
Seal:	Factory Fitted Polyurethane Seal
Insulation:	Grey Dynaphon for heat and sound
Heat Resistance:	Up to 300°C
Earthing Point:	Located at end of clip rail

Waste: 1 x 45mm Waste with overflow

Overflow:

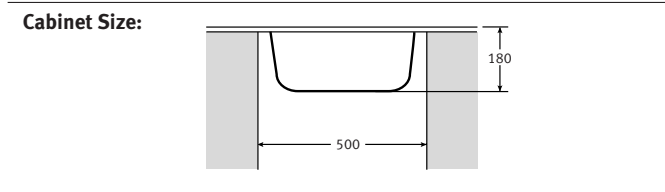
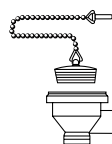

Accessories Available:



Food Preparation Platter
Mahogany

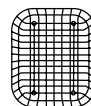

Drainer Basket
Available in White, Almond and Brown

Sink Profile: Double Edge

Fixing Clips: 'S' rail

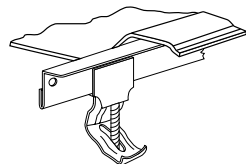
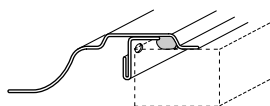

Suggested Plumbing Kit: 1 part

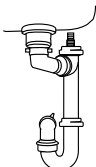

Taps: Any Franke tap can be utilised with this model*.

*Ceramic disc taps in certain installations or where there is a low head of water (below 4 metres) may not provide adequate flow rates. You are advised to check with your supplier.

Some taps may need bracing to avoid flexing of the sink ledge.

Guarantee: Franke sinks are guaranteed for 25 years against manufacturing defect. Franke taps are guaranteed against defective materials and workmanship for 1 year in relation to coatings and finishes, and 5 years in relation to moving parts. Franke will replace (and where appropriate repair) defective sinks. In relation to taps, Franke will where appropriate provide replacement parts for your taps or replace your taps. Any associated or ancillary costs to be incurred by you as a result of replacement of Franke sinks and taps under this guarantee shall in all cases be previously approved by Franke UK Limited. This guarantee is in addition to and does not affect your statutory rights.