

# Erica EUX 671 Specifications

- **Unique profile and corner radii.** Sink lies flat on worktop and cloths will not snag on corners
- **3 x 90mm Wastes with Basket Strainer Wastes.** Capable of adaptation to take Waste Disposal Unit
- **Bespoke accessories**
- **Extremely versatile and practical configuration**

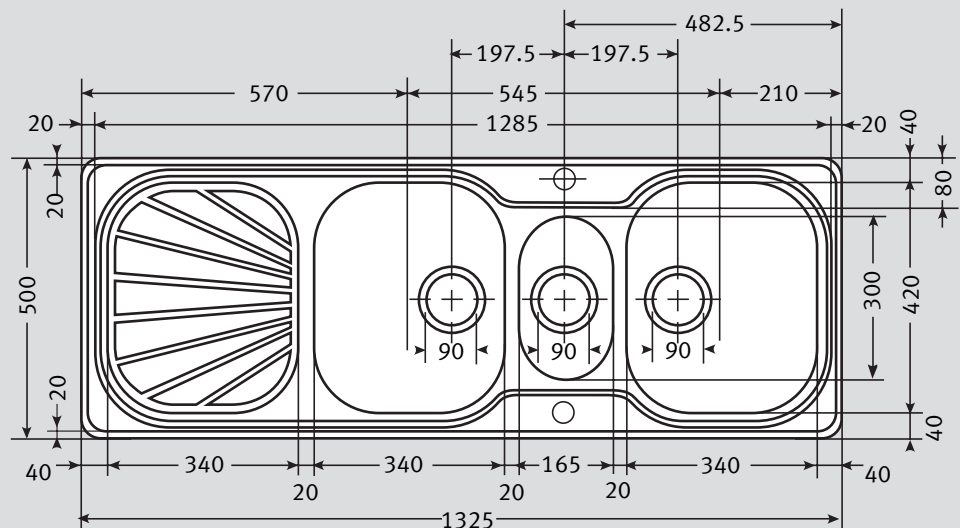
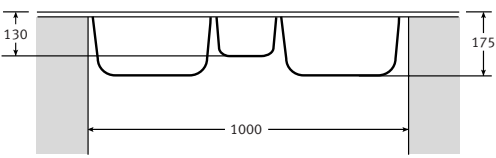

<b>Material:</b>	Stainless Steel
<b>Application:</b>	Inset or undermounted
<b>Bowl Size:</b>	340 x 420 x 175 (x2) 165 x 300 x 130 } Bowls welded to frame
<b>Drainer Format:</b>	Reversible
<b>Cut-out Size:</b>	1309 x 484 (cr=20)
<b>Colour:</b>	Silk Stainless Steel
<b>Seal:</b>	Factory Fitted Polyurethane Seal
<b>Insulation:</b>	Grey Dynaphon for heat and sound
<b>Heat Resistance:</b>	Up to 300°C
<b>Earthing Point:</b>	Located at end of clip rail
<b>Cabinet Size:</b>	

**Sink Profile:** Double Edge

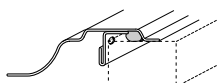

**Fixing Clips:** 'S' rail

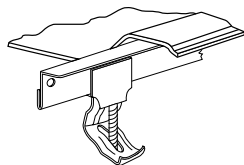

**Suggested Plumbing Kit:** 3 part

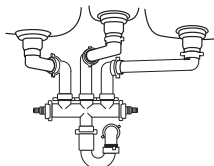

**Waste:** 1 x Lira polished 90mm Basket Strainer Waste with overflow  
2 x Lira 90mm Basket Strainer Wastes

**Overflow:**

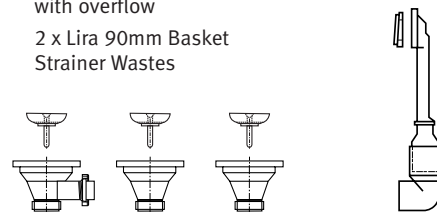

**Accessories Available:**



**Food Preparation Platter**  
Mahogany

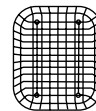

**Drainer Basket**  
Available in White, Almond and Brown



**Strainer Bowl**  
Available in White, Almond and Brown

**Taps:** Any Franke tap can be utilised with this model\*.

\*Ceramic disc taps in certain installations or where there is a low head of water (below 4 metres) may not provide adequate flow rates. You are advised to check with your supplier.

Some taps may need bracing to avoid flexing of the sink ledge.

**Guarantee:** Franke sinks are guaranteed for 25 years against manufacturing defect. Franke taps are guaranteed against defective materials and workmanship for 1 year in relation to coatings and finishes, and 5 years in relation to moving parts. Franke will replace (and where appropriate repair) defective sinks. In relation to taps, Franke will where appropriate provide replacement parts for your taps or replace your taps. Any associated or ancillary costs to be incurred by you as a result of replacement of Franke sinks and taps under this guarantee shall in all cases be previously approved by Franke UK Limited. This guarantee is in addition to and does not affect your statutory rights.